



ABOVE AND BEYOND HONING

SV-2000 SERIES

PRECISION VERTICAL HONING SYSTEM



SUNNEN'S SV-2000 SERIES: A FLEXIBLE SOLUTION THAT DELIVERS THE LOW

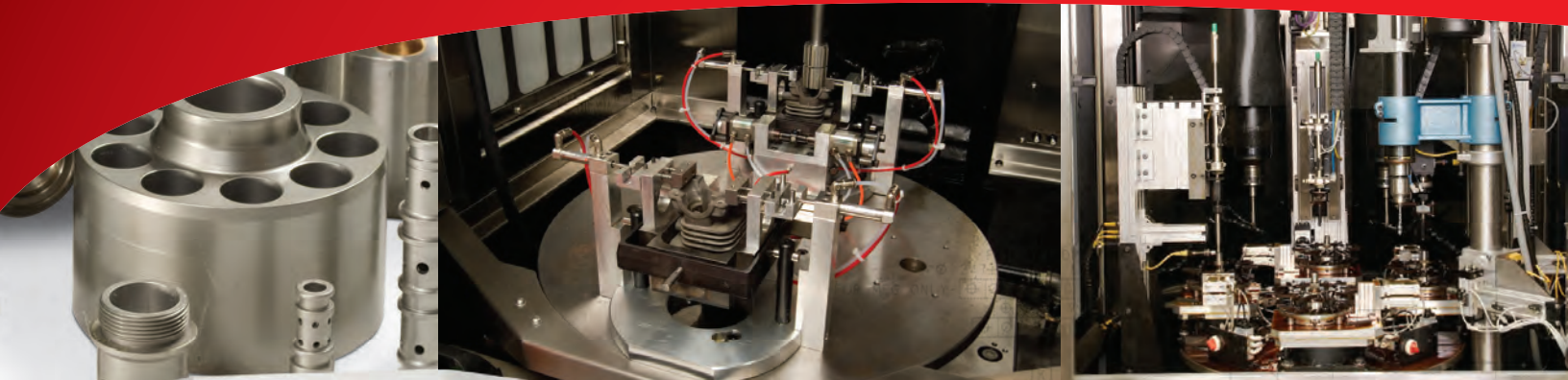

Built on a proven, modular platform, the SV-2000 Series can be easily customized and automated to suit your exact specifications – whatever your needs demand, from multiple spindles to air gaging. Plus, this flexible system supports both single-pass and conventional reciprocating honing.

The SV-2000 Series is capable of holding the industry's tightest production environment tolerances – as fine as 0,00025 mm (0.000010 inch) – tolerances far superior to I.D. grinding. This agile system is suited for an impressive range of applications, including:

- Hydraulic valves, valve bodies, and pumps
- Diesel fuel injectors
- Gears, including transmission and other precision gears

BEST COST PER HONED PART



- Gun barrels
- Gear hobs
- Refrigeration compressor components
- Turbocharger housings and bearings
- Connecting rods
- Small engine cylinders
- Medical parts

Perfect for mid- to high-production manufacturers, the SV-2000 Series delivers the lowest cost per honed part with the tight bore tolerances you expect from Sunnen.



Your Sunnen Technical Specialist will work with you to determine the best solution for your needs – it's all part of the added value you get with Sunnen. Plus, our worldwide sales and service team provides comprehensive support for the installation and operation of every system we make.

Whatever your need, we have the expertise and product range to create the right solution for you and the dedication to support you for the long run.

To find the Sunnen representative nearest you, visit our website:
www.sunnen.com



THE SV-2000 SERIES: BUILT FOR PERFORMANCE, DESIGNED FOR CUSTOMIZATION

STANDARD & OPTIONAL FEATURES

- Low maintenance stainless steel enclosure provides good visibility and ensures operator safety.
- “Lubed-for-life” over-sized stroke guideways ensure superior performance and long, trouble-free life.
- Precision high-torque output belt-drive servo spindle.
- Increased spindle power to 7.5 kW (10 hp).
- Patent-pending load-sensing feed system can operate in constant rate or pressure mode to optimize the process.
- Advanced servo stroke control allows the machine to short stroke or dwell in any part of the bore.
- New synchronized servo stroke and spindle maintain constant crosshatch finish throughout the bore from end to end.
- Multiple-spindle configurations available.
- Rugged, solid cast polymer composite base reduces vibration for enhanced performance and precision honing (standard on single-column machines; custom-welded base on multi-column configuration.)
- Brushing stations (optional brushing station shown)
- Cast iron column for increased rigidity and optimum precision.
- Flexible modular column design allows ease of customization for your specific application.
- Latest in safety technology with safety PLC and safe drive systems.



OTHER FEATURES & OPTIONS:

STANDARD ON SV-1015:

12-POSITION ROTARY AIR-UNION



CUSTOM AIR-GAGING

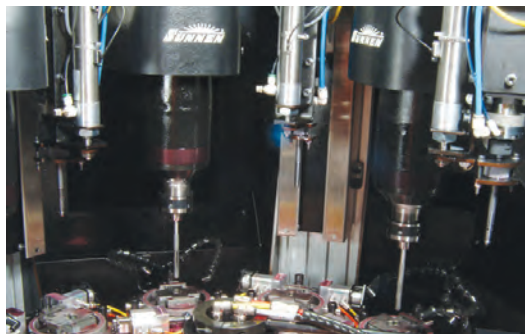

CUSTOM ROBOTIC PARTS HANDLING



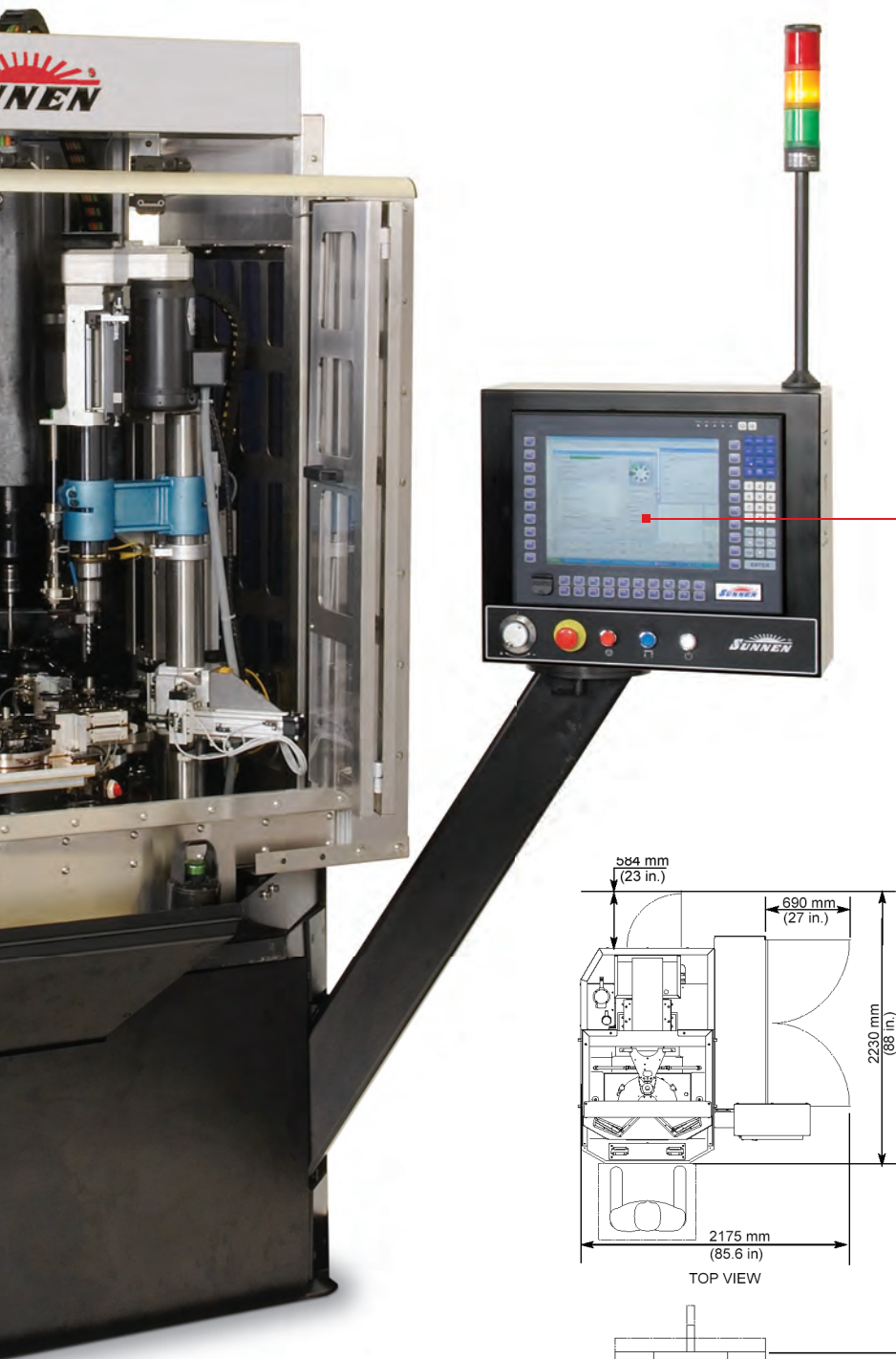

OPERATOR INTERFACE & SOFTWARE FEATURES

- Windows®-based PC touch screen control system coupled with servo column feed provides optimum process control with ease of set-up.
- Spindle speed and column speed can be varied as needed.
- Operations such as pecking, shortstroke and dwell can be easily added to the set-up.
- Programmable positions allow complex motion profiles.
- Automation interface provides seamless automation integration: robotic interface for loading and unloading; pneumatic interface for easy fixture integration.
- Multiple setups can be entered and saved for future production runs of the same components.
- State-of-the-art electronics with touch screens and hand wheel controls reduce setup time and increase machine “up time.”
- Multiple languages available.
- Automatic bore detection standard for reduction of cycle time.

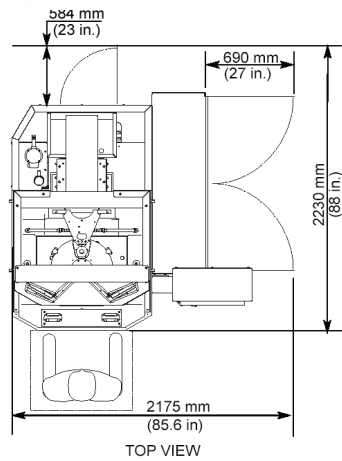

SV-2000 SERIES FLOOR PLAN LAYOUT (SV-2010/2015 shown, other models available on request)

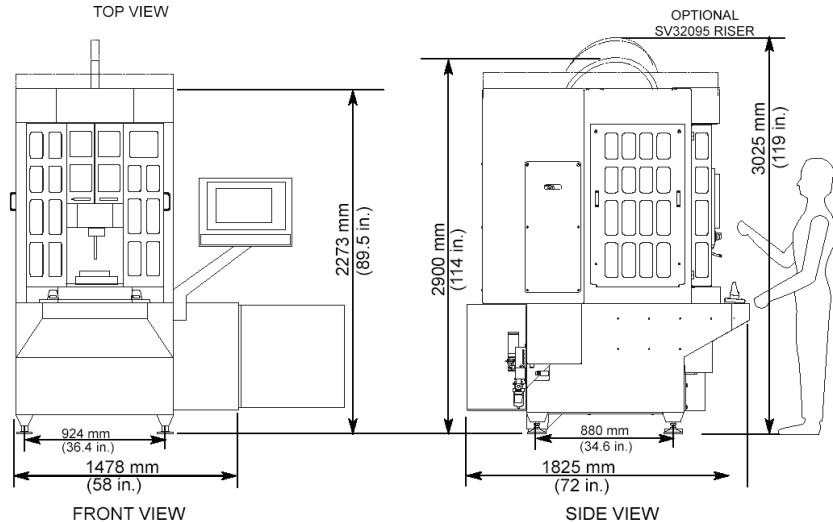

CUSTOM FIXTURES & TABLE CONFIGURATIONS

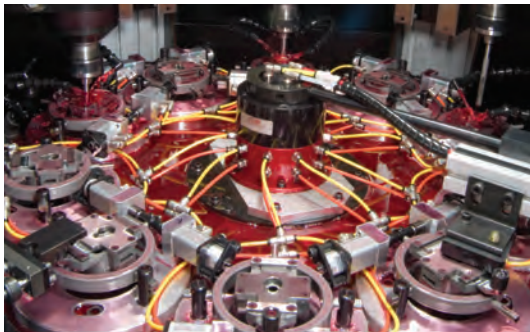



CUSTOMIZE THE SV-2000 TO YOUR EXACT REQUIREMENTS

Sunnen's high-precision honing systems represents the very finest solutions available anywhere in the world. They are reliable, durable, and flexible systems designed to deliver the production quality and precision our customers have grown to expect.

From design to delivery, you have the Sunnen commitment to service and quality assurance. Our technical experts will work with you to determine the number of spindles, style of tooling, fixturing, abrasives, in-process and/or post-process gaging, and method of parts loading and unloading (including robotics) you require. Then we'll provide you a written proposal.

After your system is built, we'll set up a live run-off demonstration at our facility. Once it meets all specifications, we'll commission your system and train your staff.

SV-2000 SERIES AUTOMATION OPTIONS



A TWO-AXIS OR MULTI-AXIS SERVO ROBOT CAN BE INTEGRATED INTO A SUNNEN MODULAR HONING SYSTEM.

Our automation options are designed to increase the operational efficiency of your precision honing system. They shorten cycle times, increase tool life, and – most importantly – radically reduce labor costs. Sunnen automation solutions can keep your system running 24 hours a day, seven days a week.

The SV-2000 series has 10 amps of additional 24 VDC control power standard for optional automation

SPECIFICATIONS:

DIAMETER RANGE:*

3 to 65 mm (.120 to 2.560 in.)

MAXIMUM WORKPIECE AND

FIXTURE WEIGHT:*

SV-2010/SV-2015: 115 kg (250 lbs)

SV-2020/SV-2052: 900 kg (2000 lbs)

WORK AREA ENVELOPE (TABLE)

SV-2010/SV-2015:

175 x 175 x 150 mm

(6.88 x 6.88 x 5.9 in.)

CARRIAGE TRAVEL SV-2010/SV-2015/

SV-2020:

630 mm (24.8 in.)

SV-2052: 1321 mm (52 in.)

STROKER SPEED:

0,001 to 0,85 mps (2 to 2000 ipm)

RECIPROICATION RATE (STROKE):

10 to 400 spm

STROKER MOTOR: 7,5 kW (10 hp)

SPINDLE SPEEDS: 100 to 4000 rpm

SPINDLE MOTOR: 7,5 kW (10.2 hp)

COOLANT SUMP PUMP:

Centrifugal Pump

(Separate Coolant Tank Required)

FLOOR SPACE

(COOLANT TANK NOT INCLUDED):

SV-2010/SV-2015:

2175 W x 2230 D x 2900 H mm

(83 x 86 x 114 in.)

SV-2020: 2561 W x 2309 D x 2611 H mm

(100.1 x 91 X 102.8 in.)

SV-2052: 2602 W x 3578 D x 3789 H mm

(102.5 x 141 x 149 in.)

FLOOR WEIGHT:

SV-2010/SV-2015: 2154 kg (4750 lbs.)

SV-2020: 4350 kg (9590 lbs.)

SV-2052: 5945 kg (13106 lbs.)

FLOOR LOAD: 2050 kg/sq. meter

(415 lbs./sq. ft) (SV-2010/SV-2015)

PNEUMATIC REQUIREMENTS: Base system

does not require air. 5,5 to 6,9 Bar (80 to 100 psi) required for special system options.

ELECTRICAL REQUIREMENTS:

460V, 60Hz, 3Ph 400V, 50Hz, 3Ph

BI-DIRECTIONAL INDEXER (SV-2015):

Infinitely adjustable servo driven, (2, 3, 4, 6, 8, 10... stations are easily configured). .001 degrees repeatability.

SV-2000 TOOLING, ABRASIVES HONING OILS AND COOLANTS

STANDARD MACHINES:

SV-2010 – base single-column machine with fixed tooling plate.

SV-2015 – same as SV-2010 but includes servo rotary table and 12-position rotary air union.

SV-2020 -standard single-column (630 mm/ 24.8 in. stroke length) with servo left/right X-axis movement (1143 mm/ 45 in.) mounted in a cast iron base with stainless steel enclosure.

SV-2052 - extended stroke length (1321 mm/ 52 in.) single-fixed column mounted on a riser with cast iron walk-in base with stainless steel enclosure.

Multi-column (both 2 and 3 column fixed-620 mm/ 24.8 in. stroked length) mounted on a welded steel base available.

STANDARD MACHINE OPTIONS:

- Adaptors available for a variety of Sunnen tooling (both floating and adjustable runout available)
- Tooling alignment gage
- Coolant system – magnetic separator/paperbed: eight configurations/sizes available
- Automatic index cycle
- Light stack
- Multi-pass cycle
- Automation PLC
- Robot interface
- Air gage wand with size feedback control loop
- Air gage servo column with size, taper, straightness feedback control loop (available for single or multiple columns)
- Additional stroke length/setup configuration
- Mist elimination system
- Work area light
- Custom risers for non-standard height workpieces
- Modular brush stations

* DIAMETER RANGE, LENGTH RANGE AND WORKPIECE WEIGHT ARE CONTINGENT ON WORKPIECE AND APPLICATION.

TOOLING

The SV-2000 Series incorporates the latest technology in vertical honing. Tooling choices include diamond or CBN multi-stone tools, plated diamond KROSSGRINDING® tools and vitrified abrasive tools.

MMT TurboHone® HIGH-PRODUCTION MULTI-STONE MANDRELS

MMT Turbohone® mandrels offer faster cycle times, superior accuracy, longer time between stone changeovers, and maintain superior bore geometry and bore centerline. Every mandrel is manufactured using high-strength steel to ensure long production life.

BORE DIAMETER RANGE (I.D.): 4 mm - 65 mm (0.156 in. - 2.56 in.)*

CGT KROSSGRINDING® DIAMOND PLATED TOOLS

CGT high-precision diamond-plated tools provide extreme accuracy, excellent stock removal capability and durable diamond grit for long tooling life. These tools provide consistent bore size and unparalleled roundness, holding tolerances to within 00025 mm (0.000010 in).

BORE DIAMETER RANGE (I.D.): 3 mm – 32 mm (.118 in. - 1.26 in.)*

SRT MULTI-STONE TOOLS

SRT multi-stone honing tools are known for their dependability for both production and high precision applications. Each uses a series of seven stone holder types, featuring replaceable abrasives to reach the specified diameter range.

BORE DIAMETER RANGE (I.D.): 35 mm – 102 mm (1.4 in. - 4.0 in.)*

TC HIGH PRECISION MANDRELS

TC precision mandrels feature a four-segment design with six to eight stones per segment or a total of 24 to 36 abrasive sticks. The abrasives are precisely arranged to ensure accurate bore geometry and no “washout” on the edges of the bore interruptions.

BORE DIAMETER RANGE (I.D.): 32 mm – 65 mm (1.26 in. - 2.56 in.)*

SINGLE STROKE® HONING TOOLS

Sunnen's line of Single Stroke® Honing tools provide fast stock removal and consistent bore geometry. With our new generation of HPH (High Production Helix) plated diamond single-pass honing tools, you can size thousands of bores with the same tool, reducing your production costs.

BORE DIAMETER RANGE (I.D.): 4 mm - 52,2 mm (.156 in. - 2.055 in.)*

* FOR DIAMETER SIZES BELOW OR ABOVE THE STANDARD RANGE, OR FOR SPECIALLY DESIGNED HIGH PRODUCTION TOOLS, CONTACT YOUR SUNNEN FIELD ENGINEER.

SUNNEN ABRASIVES

From aluminum oxide to silicon carbide to diamond and CBN, Sunnen manufactures the industry's largest variety of mounted or un-mounted stick abrasives, bond types, grain sizes and stone configurations.

Before any stone is shipped, it is graded and qualified, maintaining the most exacting quality control standards in the industry to assure you of the most precise honing performance available.

GET THE PRECISION YOU NEED WITH SUNNEN PREMIUM HONING OILS AND COOLANTS

Sunnen's premier line of honing oils and coolants provide extreme lubricity for higher honing pressure and harder abrasives, delivering faster, lower cost-per-part and ultimately more profitable cutting rates.

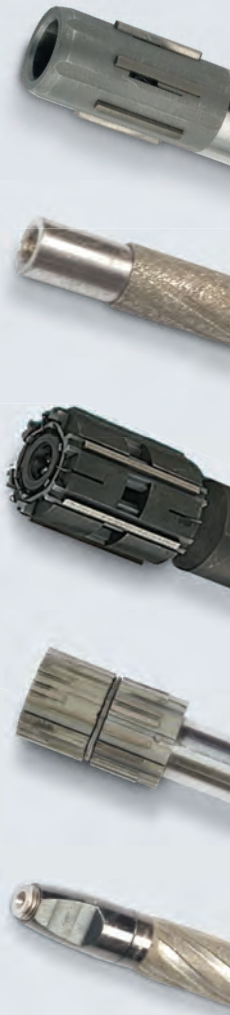



A LEGACY OF EXCELLENCE SINCE 1924.

WORLDWIDE

Our global manufacturing, distribution, and sales and service network allows us to deliver quality Sunnen solutions worldwide.

And our state-of-the-art Technical Services Centers allow our technical experts to develop innovative solutions to customer application challenges. The Centers also provide answers for customer questions and training for Sunnen representatives around the world.

SUNNEN PRODUCTS COMPANY

World Headquarters
St. Louis, MO – USA
Phone 1.314.781.2100
Fax 1.314.781.2268
Toll Free 1.800.325.3670
Email sunnen@sunnen.com
www.sunnen.com

SWITZERLAND – SUNNEN AG

Phone +41 71 649 33 33
Fax +41 71 649 33 34
Email info@sunnen.ch
www.sunnen.ch

ITALY – SUNNEN ITALIA S.R.L.

Phone +39 02 383 417 1
Fax +39 02 383 417 50
Email sunnen@sunnenitalia.com
www.sunnenitalia.com

FRANCE – SUNNEN SAS

Phone +33 01 69 30 0000
Fax +33 01 69 30 1111
Email info@sunnen.fr
www.sunnen.fr

UK – SUNNEN PRODUCTS LTD.

Phone +44 1442 39 39 39
Fax +44 1442 39 12 12
Email hemel@sunnen.co.uk
www.sunnen.co.uk

POLAND – SUNNEN POLSKA SP. Z O.O.

Phone +48 22 814 34 29
Fax +48 22 814 34 28
Email sunnen@sunnen.pl
www.sunnen.pl

RUSSIA – SUNNEN RUS

Phone +7 495 258 43 43
Fax +7 495 258 91 75
Email sunnen@sunnen-russia.ru
www.sunnen.ru

CZECH REPUBLIC – SUNNEN S.R.O.

Phone +420 383 376 317
Fax +420 383 376 316
Email sunnen@sunnen.cz
www.sunnen.cz

CHINA – SHANGHAI SUNNEN MECHANICAL CO. LTD.

Phone +86 21 5813 3990
Fax +86 21 5813 2299
Email shsunnen@sunnensh.com
www.sunnensh.com



Sunnen reserves the right to change or revise specifications and product design in connection with any feature of our products contained herein. Such changes do not entitle the buyer to corresponding changes, improvements, additions, or replacements for equipment, supplies or accessories previously sold. Information contained herein is considered to be accurate based on available information at the time of printing. Should any discrepancy of information arise, Sunnen recommends that user verify the discrepancy with Sunnen before proceeding.